

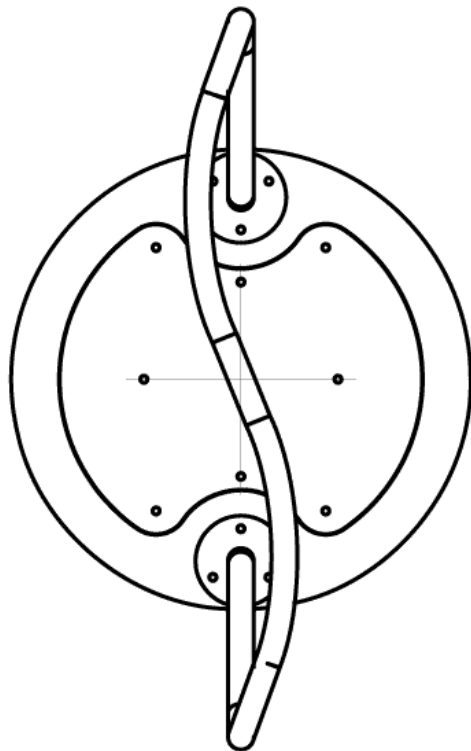

1=0.84m 2=0.84m 3=1.5m

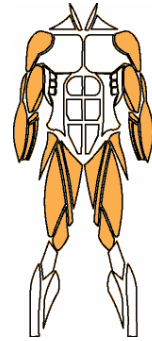

MUSCULAR STIMULATION



INTENSITY OF EFFORT



ENERGY EXPENDITURE

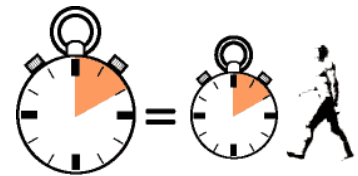

DIMENSIONS & MOVEMENTS

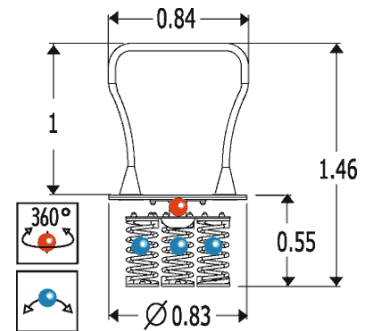

OTHER INFORMATION



4 players

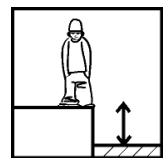

HCL= 0.55m

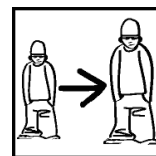

8+

Installation of equipment

Impact area = minimum safety surfacing required according to EN 1176-1

 Impact area

 Free space

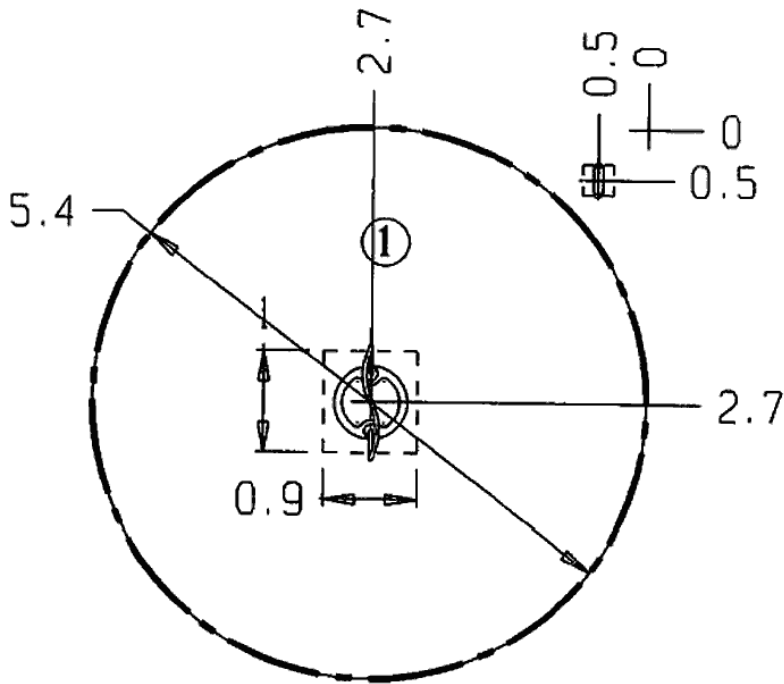

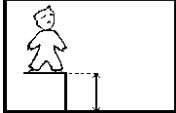
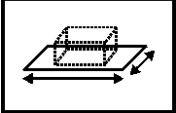
		
①	0,55m	23m ²

INSTALLATION



2

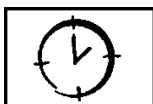

01h00

CERTIFICATIONS

