 1=2.6m 2=0.53m 3=2.35m

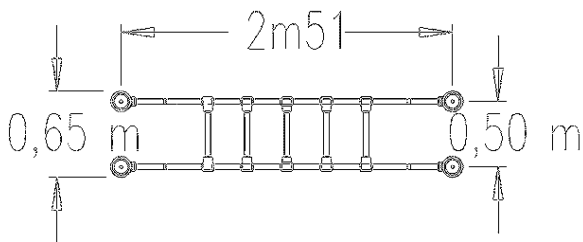

INTENSITY OF EFFORT

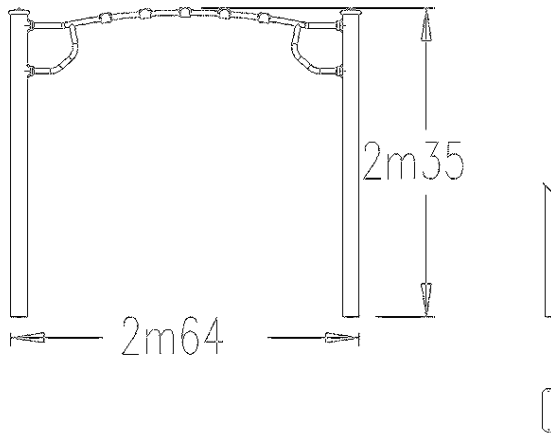

EXERCISES

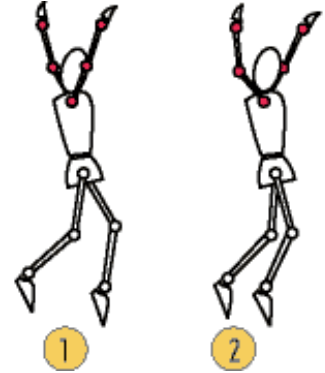

LEVELS OF EXERCISE

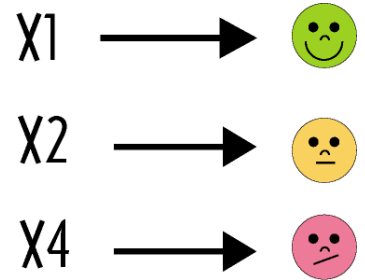

OTHER INFORMATION

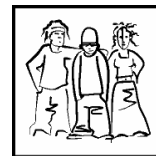

2 players

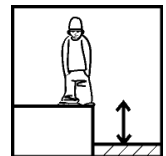

HCL= 2.3m

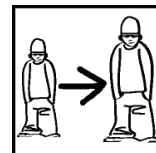

10+

Installation of equipment

Impact area = minimum safety surfacing required according to EN 1176-1

 Impact area

 Free space

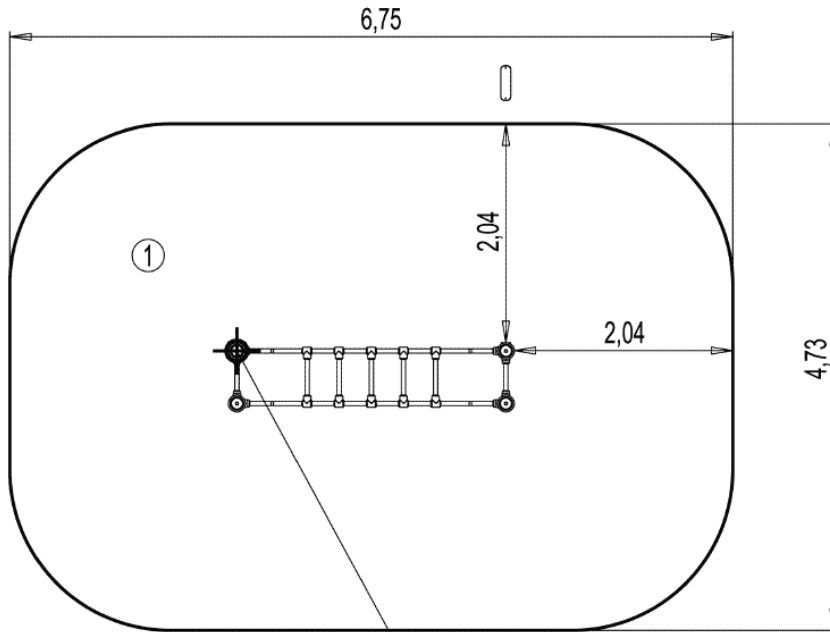

0 Point de Référence
Setting Out Point
Punto de referencia
Bezugspunkt

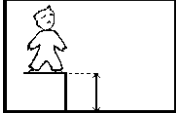
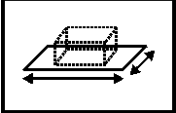
| | |
|---|---|
|  |  |
| ① | 2,30m |
| | 30m ² |

INSTALLATION

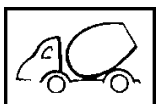

0.2m³



2

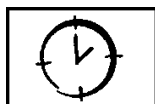

04h00

CERTIFICATIONS

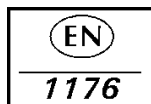

Proludic
SPORT